

Article number: 2310304105ESD

Description: E+G Antistatic base for levelling elements
LV.A-70-14-M16x108-ESD-C

Measures

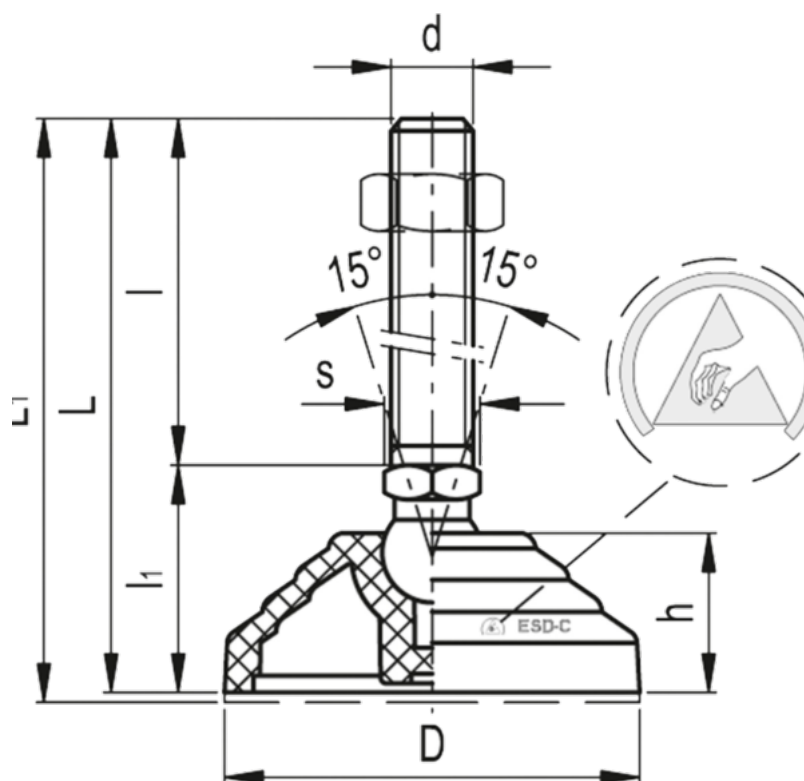

Articulation = 14
D = 70
d = M16
h = 19
l = -
l1 = -
L = 136
Max load = 14000

s = 16
Weight in (g) = 192